

COFFET DE COMMANDE VIGILEC ZERO DRAIN 2

VIGILEC ZERO V2ZBS

Drain Doble Sensor



quick start guide

Internal configuration

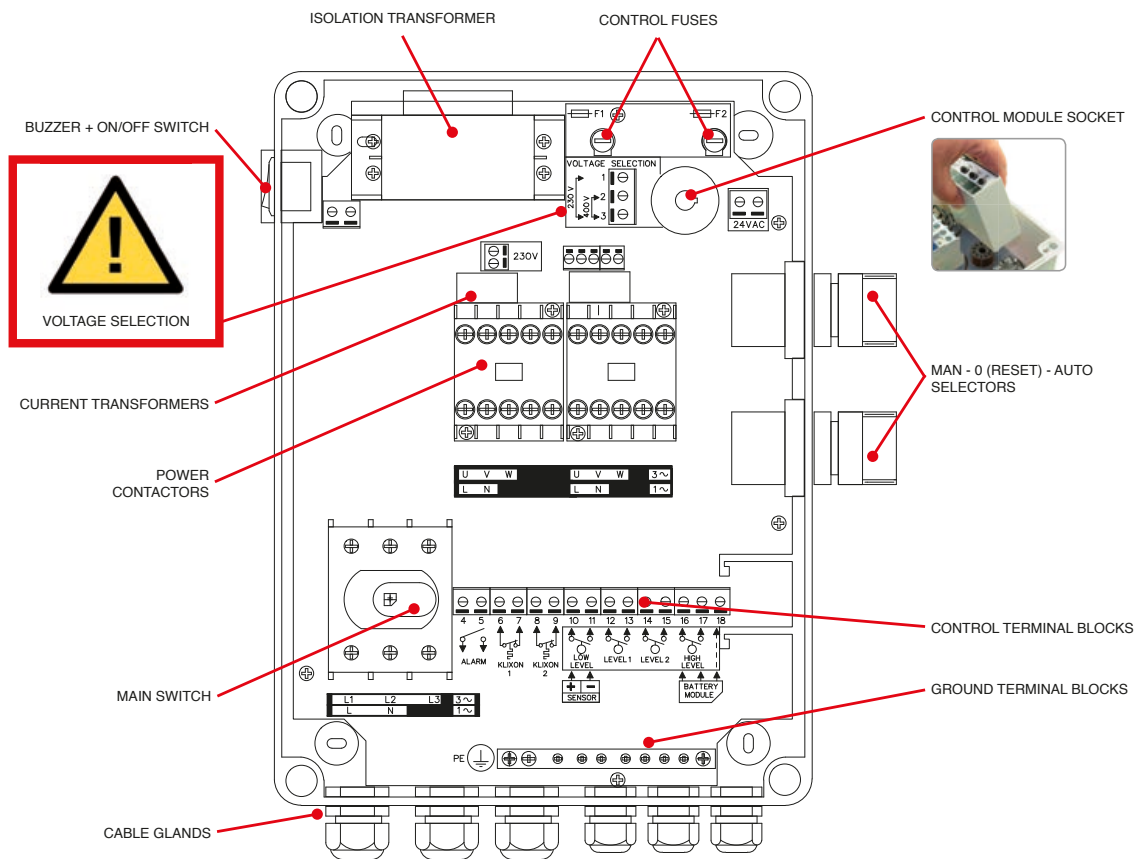

Control module

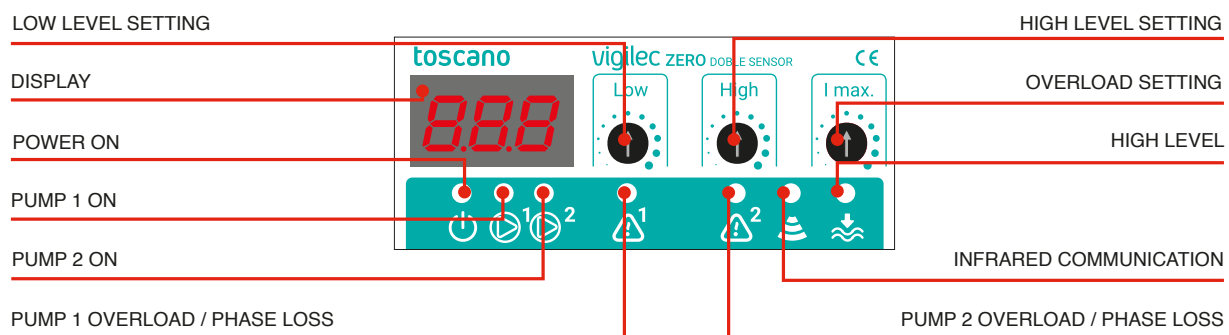

Installation

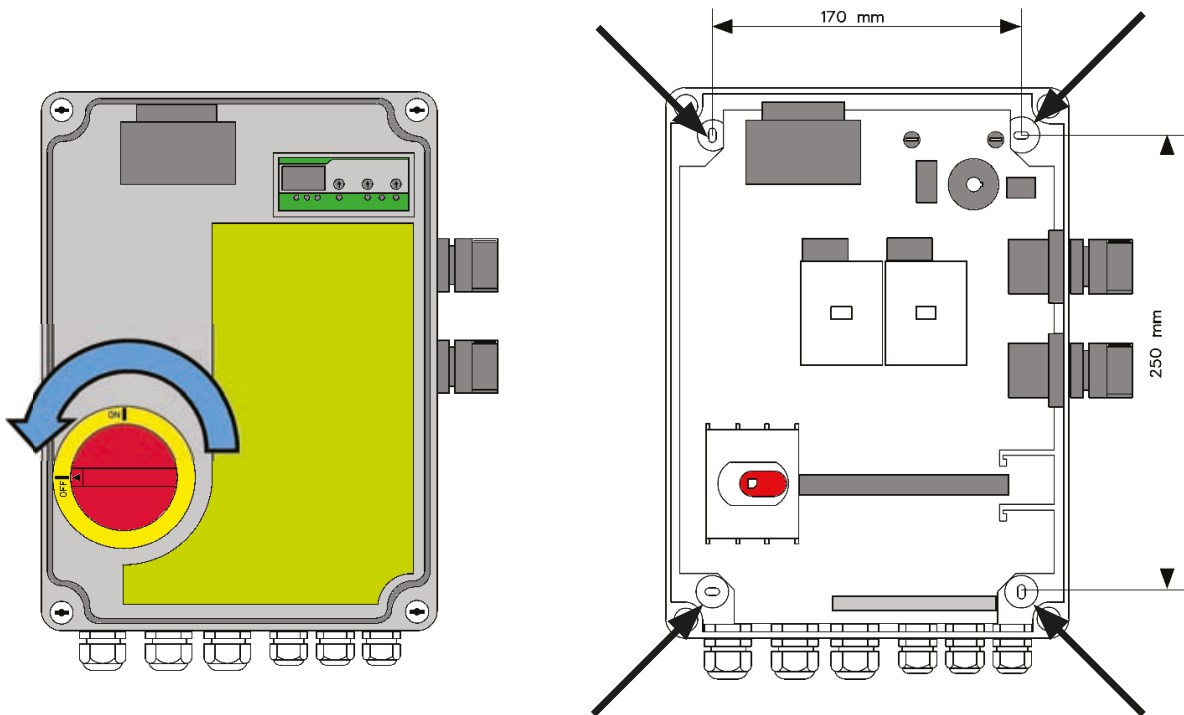

Voltage selection

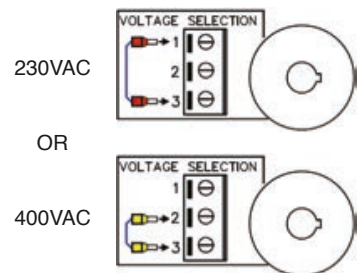
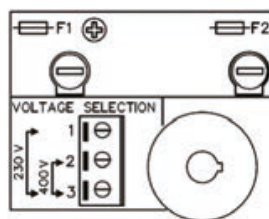

Power connections

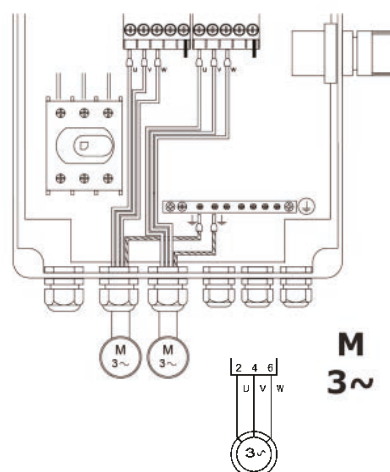
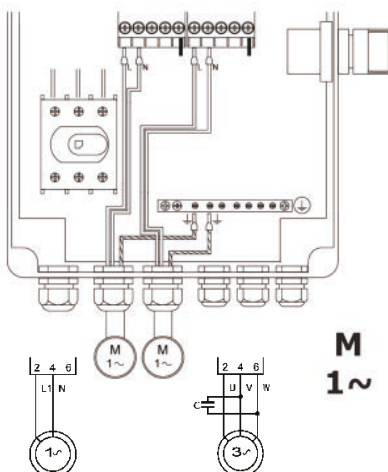
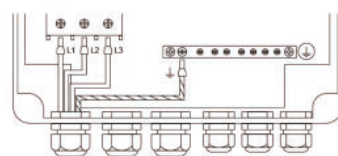
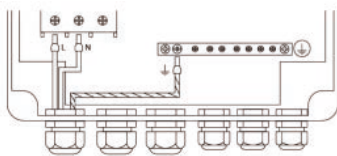

Control connections

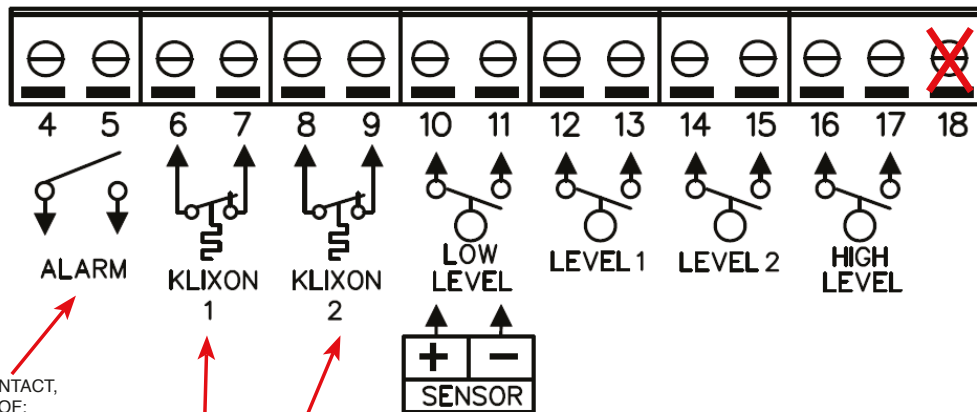

Terminal 18 is only suitable for optional modules connection (see page 8)

ALARM RELAY CONTACT, CLOSED IN CASE OF:

- POWER SUPPLY FAILURE
- PUMP FAILURE
- HIGH LEVEL
- NO PUMPS IN AUTO
- SENSOR FAILURE

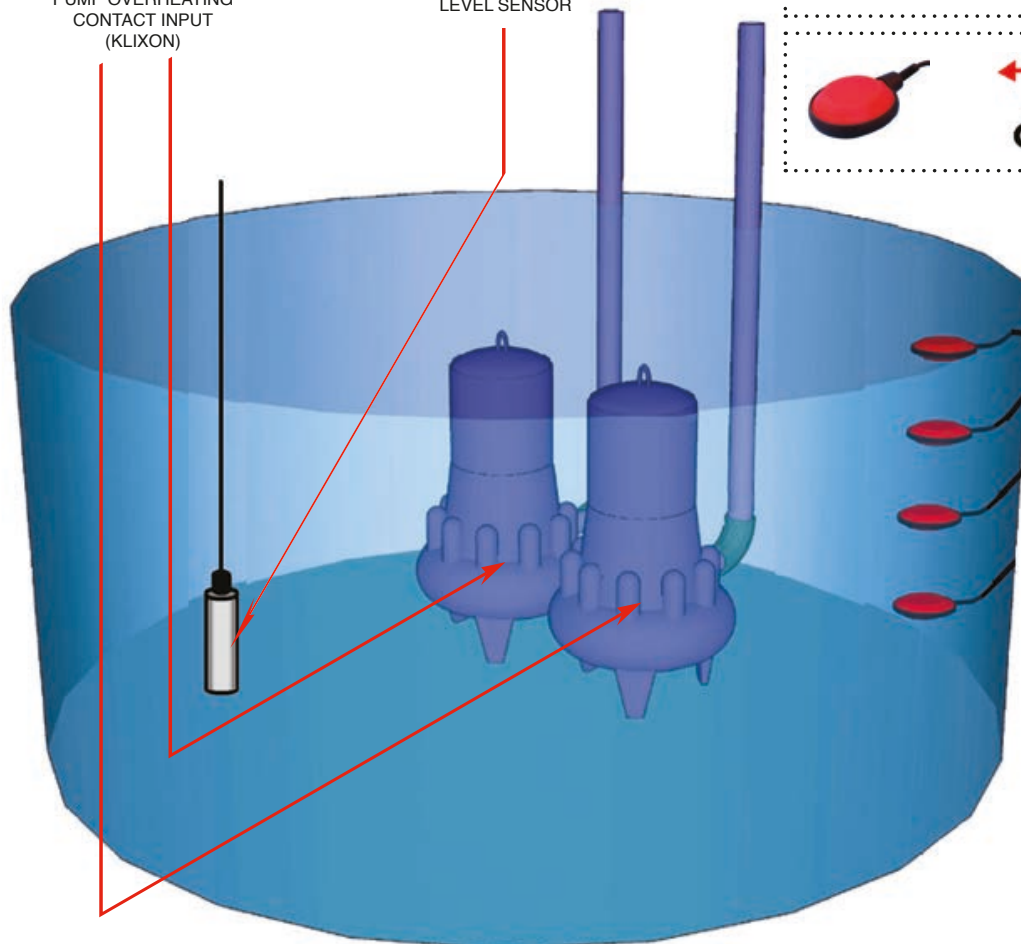
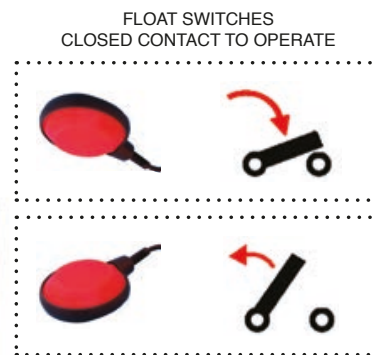
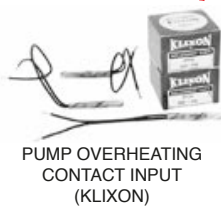

Selectors

ON
CAUTION
PUMP NOT PROTECTED

STOP
+
**ALARM
RESET**

**AUTOMATIC
MODE**

toscano vigilec ZERO DOBLE SENSOR CE
8.88 Low High I max.
MOTOR CURRENT
FLASHING LED = MAN MODE

Set-up

SWITCH ON

SETTING

SWITCH OFF

Control mode selection

SENSOR RANGE AND FLOAT SWITCH SELECTION

SENSOR OFF

1.0m
1.5m
2.0m
2.5m
3.0m
4.0m
5.0m

SEN OFF

OPTIONAL FLOAT SWITCH:
LEVEL 1, LEVEL 2
OR HIGH LEVEL

Float switch operation mode

3 FLOAT SWITCHES

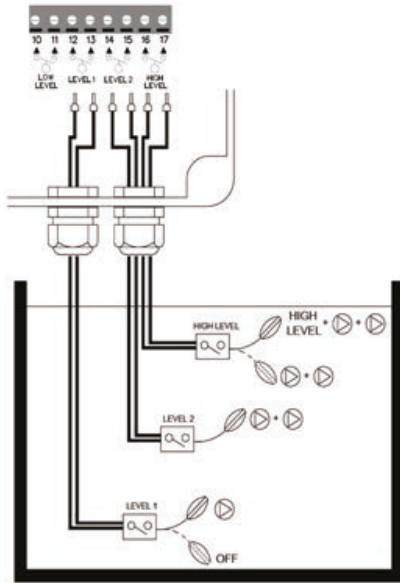

4 FLOAT SWITCHES

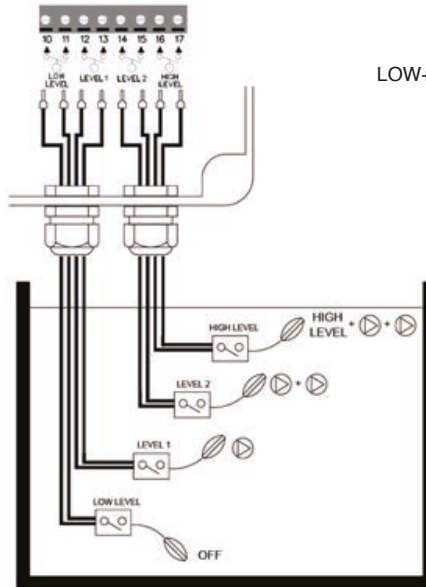

LOW+L1+L2+HIGH



LOW+L1+L2



LOW+L1



LOW



ALL OFF



4-20mA level sensor setting and operation mode

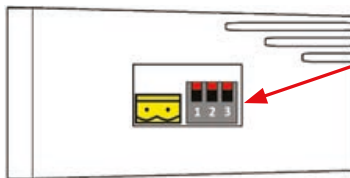

1 SELECT YOUR SENSOR RANGE
(see "control mode selection" on page 4)

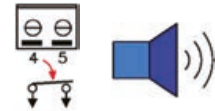

3 SETTING



LEVEL → H1

4 L2

4 L1



2 SETTING



LEVEL → L0

4 AUTOMATIC SETTING

000

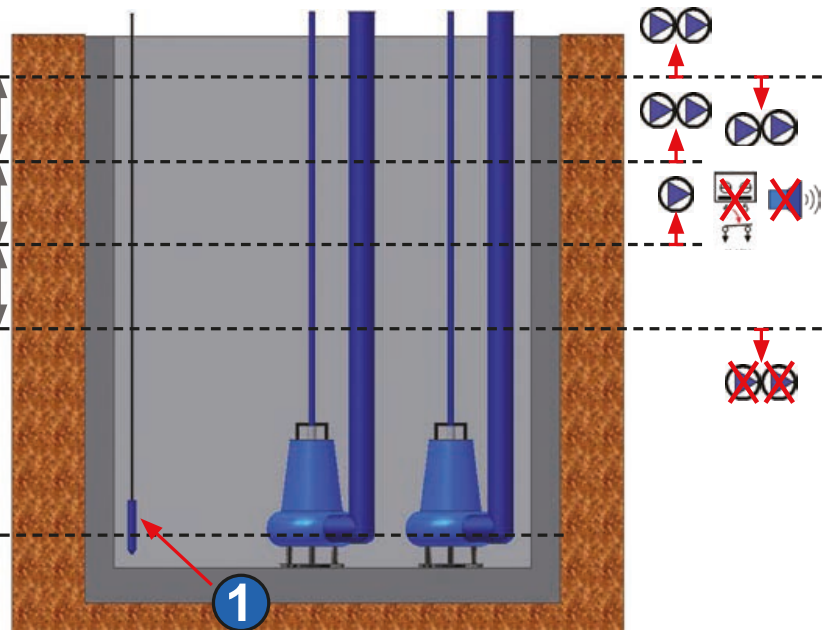

Problem detection

Supply failure

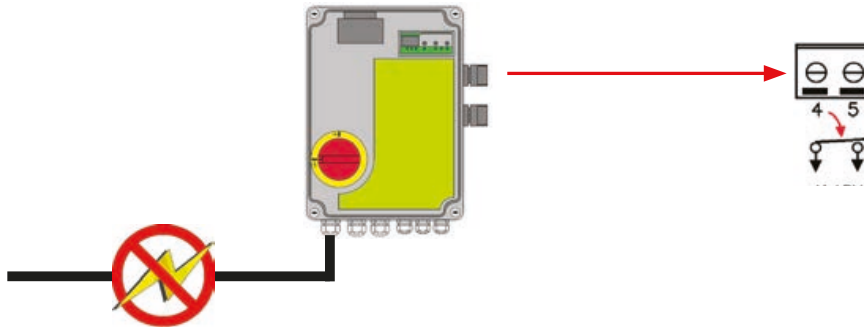

Pump failure

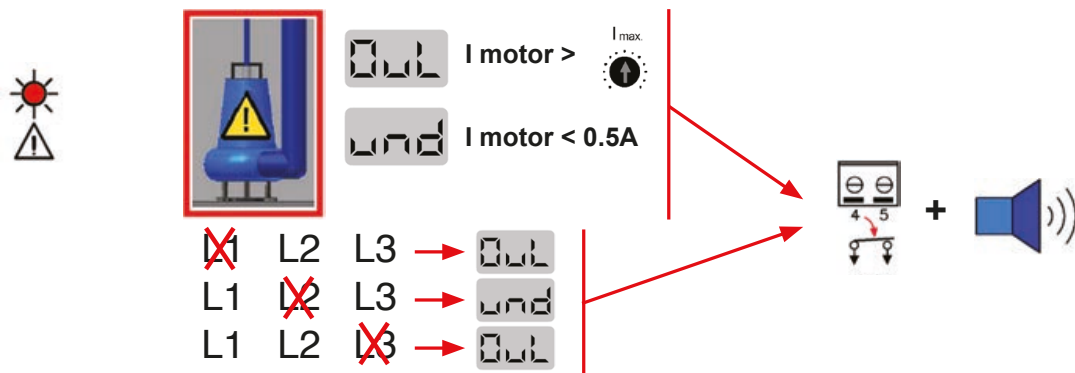

No pumps in AUTO

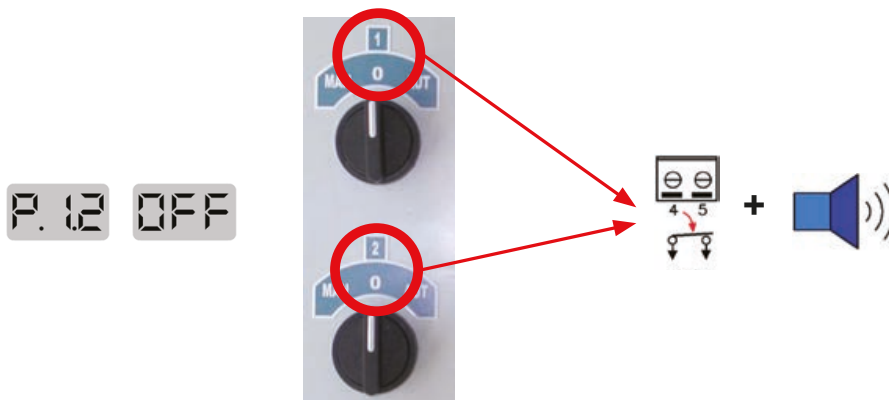

Sensor failure (4-20mA sensor control)



5E7 5.c. I sensor > 20mA
5E7 0.c. I sensor < 4mA

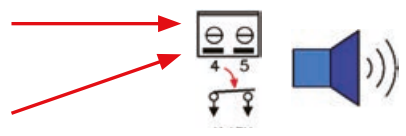

Jammed impeller preventive system

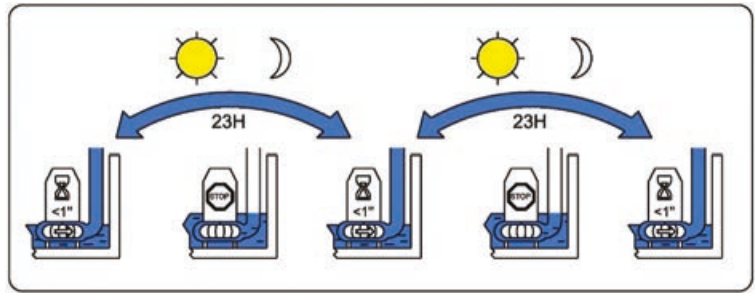

Pump-Check

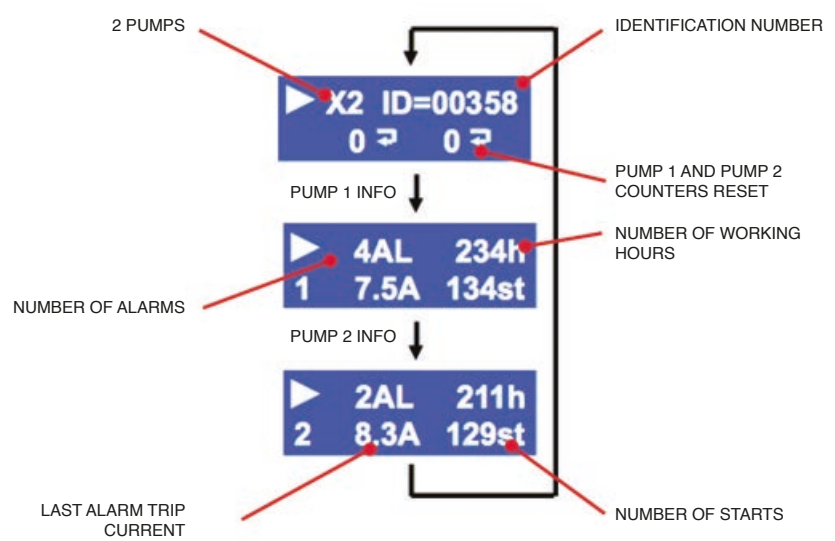

Other functions / additional options

- Pump alternation with delayed start and stop for pumps.
- Automatic pump commutation in case of failure or deactivation of one of them.
- Additional options: main circuit breaker, bimetallic overload relay or phase sequence relay.

Optional modules (direct installation on control terminal blocks)

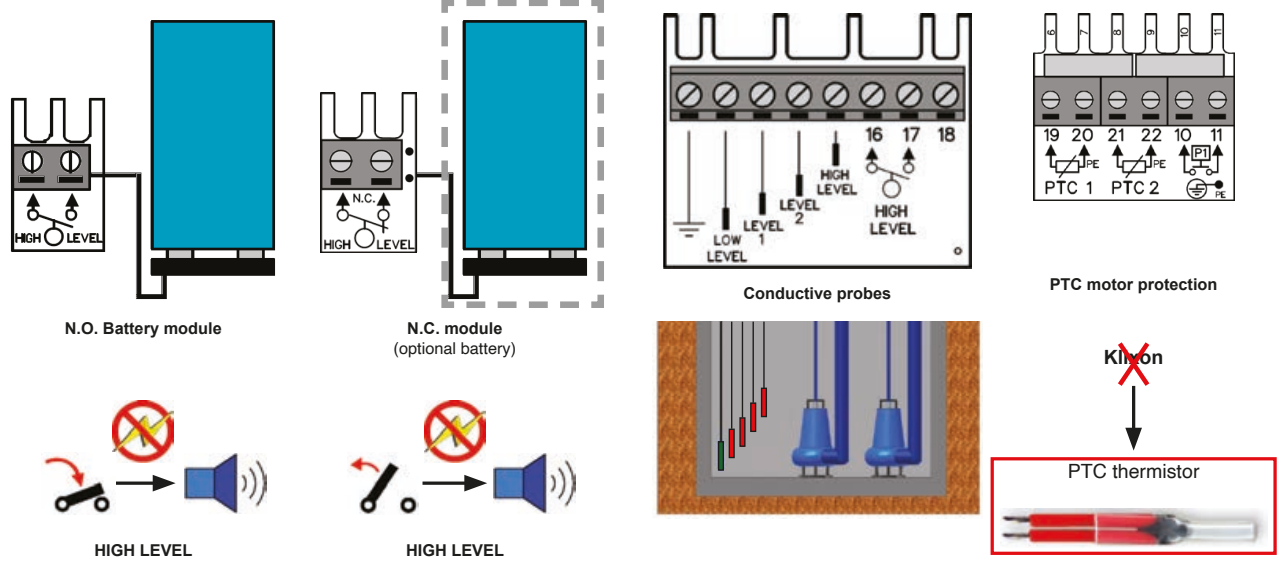

Technical specifications



Supply voltage	230Vac I/III or 400Vac III (selectable) -20%...+30% - 50/60Hz
Control transformer	230-400Vac / 24Vac, primary fuse: 0.2A (F1), secondary fuse: 0.8A (F2)
Pump current range	1...12A (V2ZBS) / 5...16A (V2ZBS-E) / 5...22A (V2ZBS-F) - AC3
Overload setting (Imax)	1.1...13A (V2ZBS) / 5.1...30A (V2ZBS-E/F) / alarm trip in 7 seconds
Control mode	Float switches and/or 4-20mA level sensor or conductive probe (+optional module)
Control input voltage	24Vdc (float switches)
4-20mA sensor supply voltage	24Vdc
Sensor range	1m, 1.5m, 2m, 2.5m, 3m, 4m ou 5m (selectable)
Sensor failure detection	Open circuit and short circuit
Low level setting	10cm...sensor range
High level setting	Low level + 10cm...sensor range
Level 2 setting	Automatic setting: 2/3 (high level - low level)
Level 1 setting	Automatic setting: 1/3 (high level - low level)
Dry level setting	Automatic setting: 1/2 low level
Terminal block wiring size	10mm ² (power supply) 4mm ² (control)
Protections	Overload, phase failure and pump overheating (Klixon contacts)
Alarm contact	5A 250Vac
Alarm contact activation	Overload, phase failure, sensor failure, high level, no pumps in AUTO and power supply failure
Acoustic alarm	12Vdc - 90dB
Records (PUMPCHECK)	Module identification number, counters resets, pumps running hours, pumps starts, pumps alarms and last alarm tripping current
Size / Weight / IP / Temperature	300 (h) x 220 (w) x 120 (d) mm / 3550g / IP65 / -10°...+55° C
Cable gland configuration	1xM25 (main supply) / 2xM20 (motors) / 6xM16 (controls)